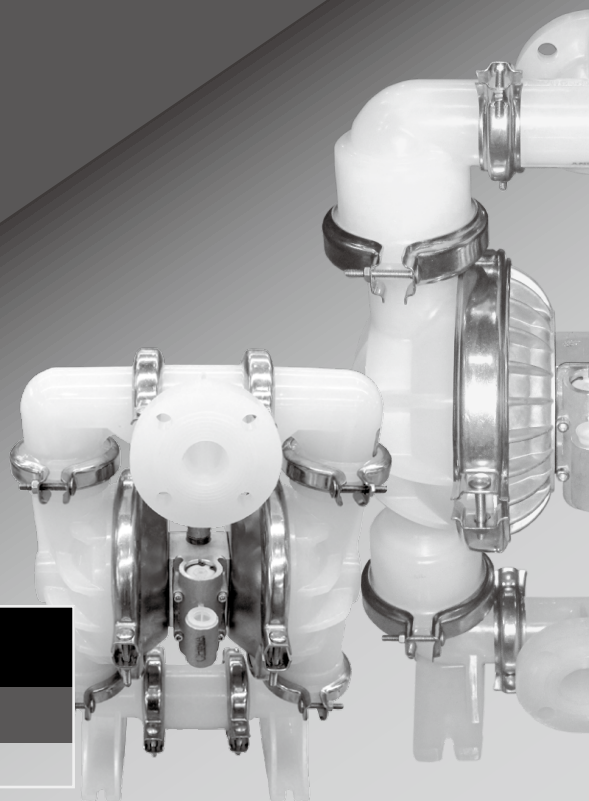


# WILDEN®

**EOM**  
Engineering  
Operation &  
Maintenance



**TZ8**  
Original™ Series  
PLASTIC PUMPS

**TURBO-FLO™ Z**  
PROGRESSIVE PUMP TECHNOLOGY



*Where Innovation Flows.*

[www.wildenpump.com](http://www.wildenpump.com)  
[cn.psgdover.com](http://cn.psgdover.com)

**TABLE OF CONTENTS**

**SECTION 1 CAUTIONS—READ FIRST! . . . . . 1**

**SECTION 2 WILDEN® PUMP DESIGNATION SYSTEM . . . . . 2**

**SECTION 3 HOW IT WORKS—PUMP DISTRIBUTION SYSTEM. . . . . 3**

**SECTION 4 DIMENSIONAL DRAWING(S) . . . . . 4**

**SECTION 5**

**A. PERFORMANCE**

Rubber-Fitted . . . . . 5

TPE-Fitted . . . . . 5

PTFE-Fitted . . . . . 6

**B. SUCTION LIFT . . . . . 7**

**SECTION 6 SUGGESTED INSTALLATION . . . . . 8**

Operation/Maintenance . . . . . 9

Troubleshooting. . . . . 10

**SECTION 7 PUMP DISASSEMBLY . . . . . 11**

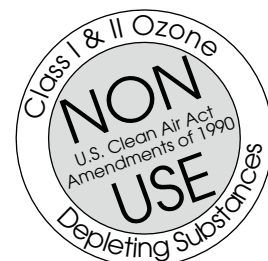
Air Valve/Center Block Disassembly. . . . . 14

Reassembly Hints & Tips. . . . . 16

**SECTION 8 EXPLODED VIEW AND PARTS LISTING. . . . . 17**

TZ8 Plastic Rubber/TPE/PTFE-Fitted. . . . . 17

**SECTION 9 ELASTOMER OPTIONS . . . . . 19**



## CAUTIONS — READ FIRST!

**TEMPERATURE LIMITS:**

Polypropylene	0°C to 79°C	32°F to 175°F
PVDF	-12°C to 107°C	10°F to 225°F
Nylon	-17.8°C to 93.3°C	0°F to 200°F
Neoprene	-17.8°C to 93.3°C	0°F to 200°F
Buna-N	-12.2°C to 82.2°C	10°F to 180°F
EPDM	-51.1°C to 137.8°C	-60°F to 280°F
FKM	-40°C to 176.7°C	-40°F to 350°F
Wil-Flex™	-40°C to 107.2°C	-40°F to 225°F
Saniflex™	-28.9°C to 104.4°C	-20°F to 220°F
PTFE	4.4°C to 104.4°C	40°F to 220°F



**CAUTION:** When choosing pump materials, be sure to check the temperature limits for all wetted components. Example: FKM has a maximum limit of 176.7°C (350°F) but polypropylene has a maximum limit of only 79°C (175°F).



**CAUTION:** Maximum temperature limits are based upon mechanical stress only. Certain chemicals will significantly reduce maximum safe operating temperatures. Consult engineering guide for chemical compatibility and temperature limits.



**CAUTION:** Always wear safety glasses when operating pump. If diaphragm rupture occurs, material being pumped may be forced out air exhaust.



**WARNING:** Prevention of static sparking — If static sparking occurs, fire or explosion could result. Pump, valves, and containers must be properly grounded when handling flammable fluids and whenever discharge of static electricity is a hazard.



**CAUTION:** Do not exceed 8.6 bar (125 psig) air supply pressure.



**CAUTION:** Plastic-series pumps are made of virgin plastic and are not UV stabilized. Direct sunlight for prolonged periods can cause deterioration of plastics.



**CAUTION:** Before any maintenance or repair is attempted, the compressed air line to the pump should be disconnected and all air pressure allowed to bleed from pump. Disconnect all intake, discharge and air lines. Drain the pump by turning it upside down and allowing any fluid to flow into a suitable container.



**CAUTION:** Blow out air line for 10 to 20 seconds before attaching to pump to make sure all pipe line debris is clear. Use an in-line air filter. A 5µ (micron) air filter is recommended.



**NOTE:** Tighten clamp bands and retainers prior to installation. Fittings may loosen during transportation.



**NOTE:** When installing PTFE diaphragms, it is important to tighten outer pistons simultaneously (turning in opposite directions) to ensure tight fit.



**NOTE:** Before starting disassembly, mark a line from each liquid chamber to its corresponding air chamber. This line will assist in proper alignment during reassembly.



**CAUTION:** Verify the chemical compatibility of the process and cleaning fluid to the pump's component materials in the Chemical Resistance Guide (see E4).



**CAUTION:** When removing the end cap using compressed air, the air valve end cap may come out with considerable force. Hand protection such as a padded glove or rag should be used to capture the end cap.



**NOTE:** TZ-Series pumps do not need lubrication.



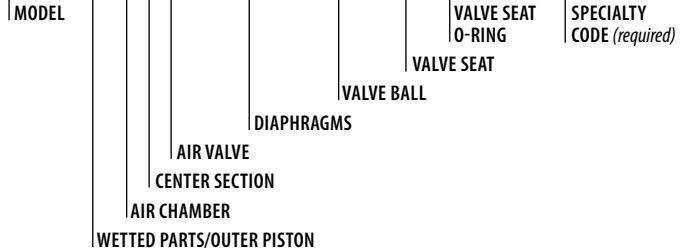
**NOTE:** TZ1 Plastic PTFE-fitted pumps come standard from the factory with expanded PTFE gaskets.

**TZ8 PLASTIC**

**51 mm (2") Pump  
Maximum Flow Rate:  
582 LPM (154 GPM)**

**LEGEND**

**TZ8 / XXXXX / XXX / XX / XXX / XXXX**



**MATERIAL CODES**

**MODEL**

TZ8 = 51 mm (2")

**WETTED PARTS / OUTER PISTON**

PK = POLYPROPYLENE / PVDF

**AIR CHAMBER**

A = ALUMINUM

**CENTER SECTION**

A = ALUMINUM

**AIR VALVE**

B = BRASS

**DIAPHRAGMS**

BNS = BUNA-N (red dot)

EPS = EPDM (blue dot)

FSS = SANIFLEX™ (cream dot)

NES = NEOPRENE (green dot)

TEU = PTFE W/ EPDM BACK-UP

TNU = PTFE W/ NEOPRENE BACK-UP

TSU = PTFE W/ SANIFLEX™ BACK-UP

VTS = FKM (white dot)

WFS = WIL-FLEX™ (orange dot)

ZWS = WIL-FLEX™,EZ-INSTALL

TWS = FULL-STOKE PTFE W/WIL-FLEX™ BACK-UP

**VALVE BALL**

BN = BUNA-N (red dot)

EP = EPDM (blue dot)

FS = SANIFLEX™ (cream dot)

NE = NEOPRENE (green dot)

TF = PTFE

VT = FKM (white dot)

WF = WIL-FLEX™ (orange dot)

**VALVE SEAT**

P = POLYPROPYLENE

**VALVE SEAT O-RING**

BN = BUNA-N

TV = PTFE ENCAP/FKM

WF = WIL-FLEX™ [Santoprene® (orange dot)]

**SPECIALTY CODES**

0504 DIN Flange

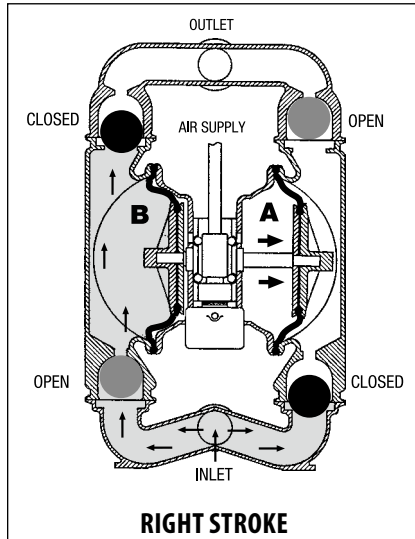
**NOTE:** Most elastomeric materials use colored dots for identification.

**NOTE:** Not all models are available with all material options.

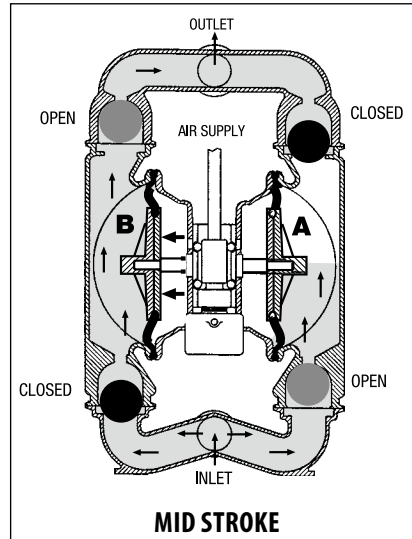
Hytrel® is registered trademarks of DuPont Dow Elastomers.

## HOW IT WORKS—PUMP DISTRIBUTION SYSTEM

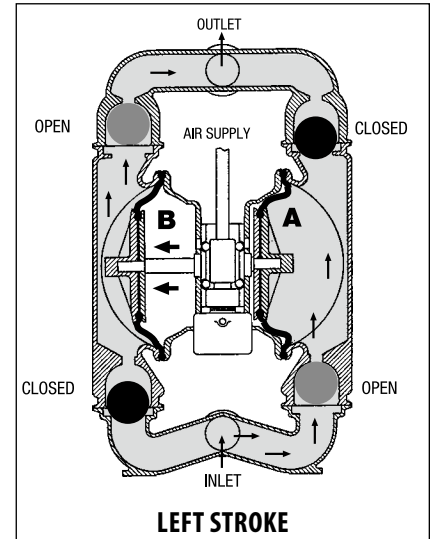
The Wilden® diaphragm pump is an air-operated, positive displacement, self-priming pump. These drawings show the flow pattern through the pump upon its initial stroke. It is assumed the pump has no fluid in it prior to its initial stroke.



**FIGURE 1** The air valve directs pressurized air to the back side of diaphragm A. The compressed air is applied directly to the liquid column separated by elastomeric diaphragms. The diaphragm acts as a separation membrane between the compressed air and liquid, balancing the load and removing mechanical stress from the diaphragm. The compressed air moves the diaphragm away from the center block of the pump. The opposite diaphragm is pulled in by the shaft connected to the pressurized diaphragm. Diaphragm B is on its suction stroke; air behind the diaphragm has been forced out to the atmosphere through the exhaust port of the pump. The movement of diaphragm B toward the center block of the pump creates a vacuum within chamber B. Atmospheric pressure forces fluid into the inlet manifold forcing the inlet valve ball off its seat. Liquid is free to move past the inlet valve ball and fill the liquid chamber (see shaded area).

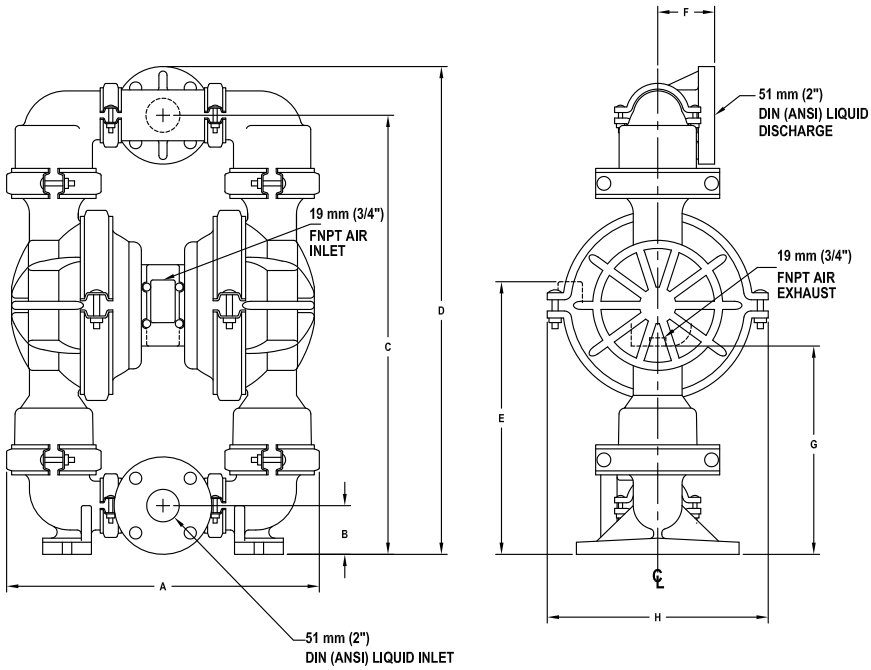


**FIGURE 2** When the pressurized diaphragm, diaphragm A, reaches the limit of its discharge stroke, the air valve redirects pressurized air to the back side of diaphragm B. The pressurized air forces diaphragm B away from the center block while pulling diaphragm A to the center block. Diaphragm B is now on its discharge stroke. Diaphragm B forces the inlet valve ball onto its seat due to the hydraulic forces developed in the liquid chamber and manifold of the pump. These same hydraulic forces lift the discharge valve ball off its seat, while the opposite discharge valve ball is forced onto its seat, forcing fluid to flow through the pump discharge. The movement of diaphragm A toward the center block of the pump creates a vacuum within liquid chamber A. Atmospheric pressure forces fluid into the inlet manifold of the pump. The inlet valve ball is forced off its seat allowing the fluid being pumped to fill the liquid chamber.



**FIGURE 3** At completion of the stroke, the air valve again redirects air to the back side of diaphragm A, which starts diaphragm B on its exhaust stroke. As the pump reaches its original starting point, each diaphragm has gone through one exhaust and one discharge stroke. This constitutes one complete pumping cycle. The pump may take several cycles to completely prime depending on the conditions of the application.

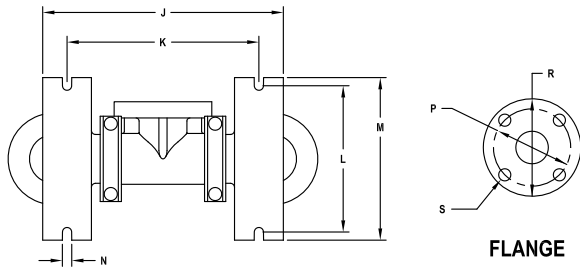
**TZ8 PLASTIC**



**DIMENSIONS**

ITEM	METRIC (mm)	STANDARD (inch)
A	490	19.3
B	76	3.0
C	693	27.3
D	770	30.3
E	447	17.6
F	89	3.5
G	345	13.6
H	333	13.1
J	386	15.2
K	307	12.1
L	229	9.0
M	254	10.0
N	15	0.6
	<b>DIN (mm)</b>	<b>ANSI (inch)</b>
P	125 DIA.	4.8 DIA.
R	165 DIA.	6.0 DIA.
S	18 DIA.	0.8 DIA.

REV A





PERFORMANCE

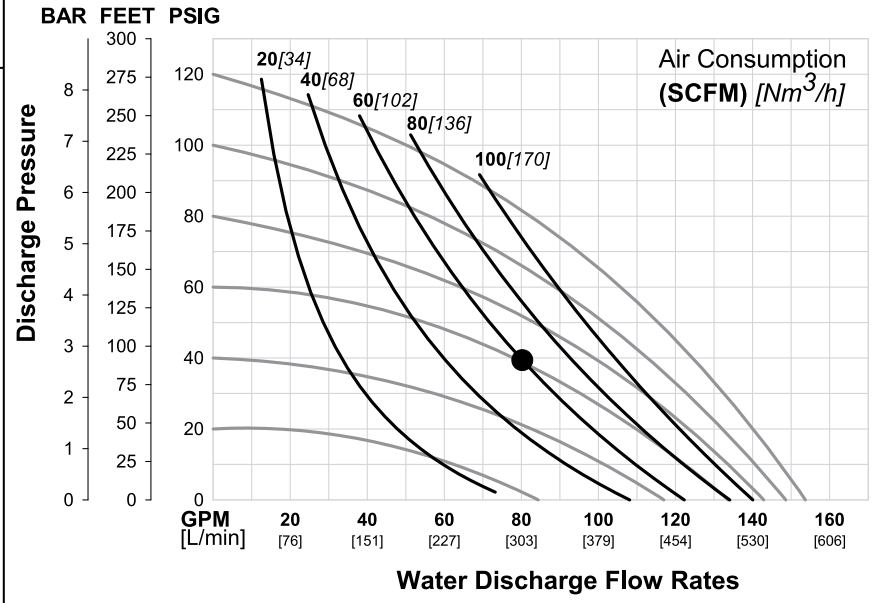
**TZ8 PLASTIC RUBBER-FITTED**

Height .....	770 mm (30.3")
Width .....	490 mm (19.3")
Depth .....	333 mm (13.1")
Ship Weight .....	35 kg (77 lbs)
Air Inlet .....	19 mm (3/4")
Inlet .....	51 mm (2")
Outlet .....	51 mm (2")
Suction Lift .....	5.9 m Dry (19.3') 9.0 m Wet (29.5')
Disp. Per Stroke .....	2.8 l (0.74 gal) <sup>1</sup>
Max. Flow Rate .....	582 lpm (154 gpm)
Max. Size Solids .....	6.4 mm (1/4")

<sup>1</sup>Displacement per stroke was calculated at 4.8 bar (70 psig) air inlet pressure against a 2 bar (30 psig) head pressure.

**Example:** To pump 303 lpm (80 gpm) against a pressure of 2.8 bar (40 psi) requires 4.3 bar (62 psig) and 135.2 Nm<sup>3</sup>/h (80 scfm) air consumption. (See dot on chart.)

**CAUTION:** Do not exceed 8.6 bar (125 psig) air supply pressure.



Flow rates indicated on chart were determined by pumping water.

For optimum life and performance, pumps should be specified so that daily operation parameters will fall in the center of the pump performance curve.

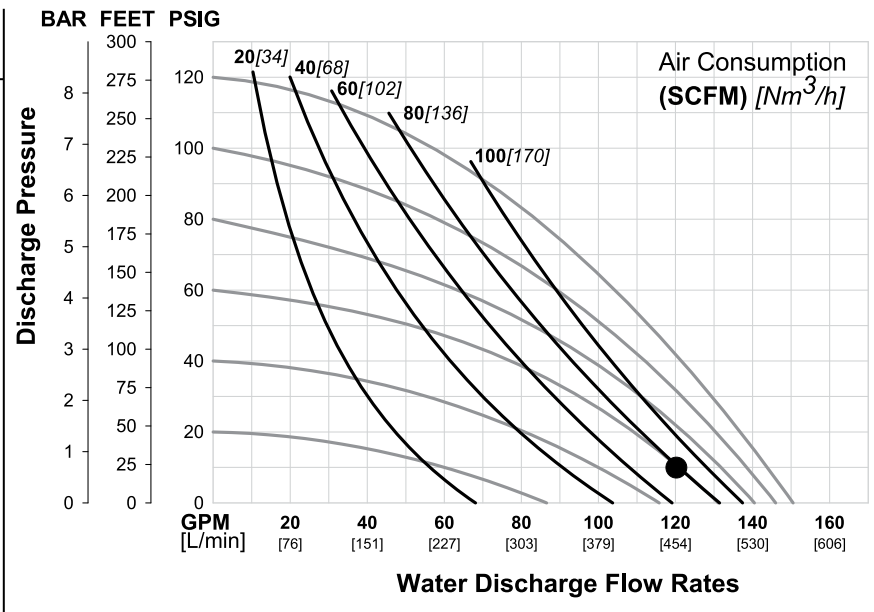
**TZ8 PLASTIC TPE-FITTED**

Height .....	770 mm (30.3")
Width .....	490 mm (19.3")
Depth .....	333 mm (13.1")
Ship Weight .....	35 kg (77 lbs)
Air Inlet .....	19 mm (3/4")
Inlet .....	51 mm (2")
Outlet .....	51 mm (2")
Suction Lift .....	5.0 m Dry (16.5') 8.6 m Wet (28.4')
Disp. Per Stroke .....	2.8 l (0.74 gal) <sup>1</sup>
Max. Flow Rate .....	570 lpm (151 gpm)
Max. Size Solids .....	6.4 mm (1/4")

<sup>1</sup>Displacement per stroke was calculated at 4.8 bar (70 psig) air inlet pressure against a 2 bar (30 psig) head pressure.

**Example:** To pump 454 lpm (120 gpm) against a pressure of .7 bar (10 psi) requires 4.1 bar (60 psig) and 135.2 Nm<sup>3</sup>/h (80 scfm) air consumption. (See dot on chart.)

**CAUTION:** Do not exceed 8.6 bar (125 psig) air supply pressure.



Flow rates indicated on chart were determined by pumping water.

For optimum life and performance, pumps should be specified so that daily operation parameters will fall in the center of the pump performance curve.

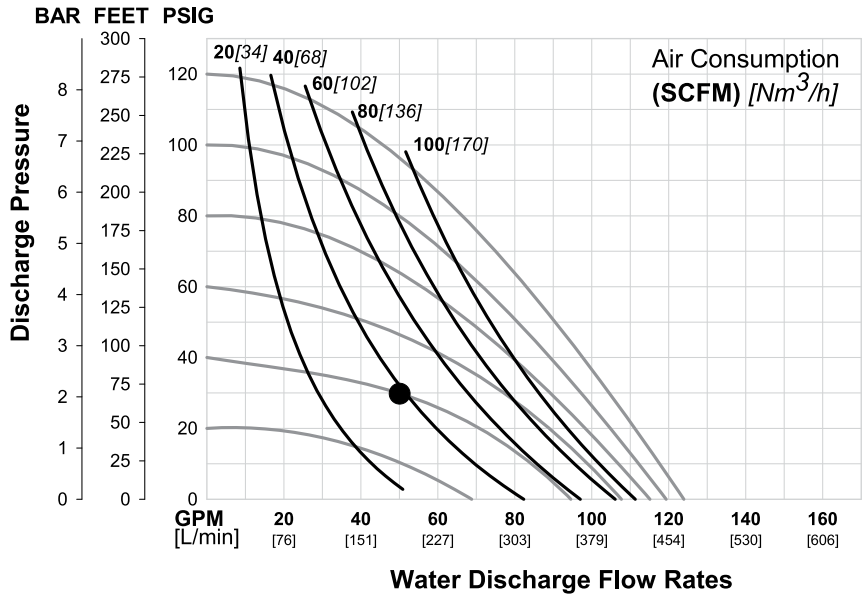
**TZ8 PLASTIC  
PTFE-FITTED**

Height .....	770 mm (30.3")
Width .....	490 mm (19.3")
Depth .....	333 mm (13.1")
Ship Weight .....	35 kg (77 lbs)
Air Inlet .....	19 mm (3/4")
Inlet .....	51 mm (2")
Outlet .....	51 mm (2")
Suction Lift .....	3.5 m Dry (11.4")
	8.6 m Wet (28.4")
Disp. Per Stroke .....	1.6 l (0.43 gal) <sup>1</sup>
Max. Flow Rate .....	469 lpm (124 gpm)
Max. Size Solids .....	6.4 mm (1/4")

<sup>1</sup>Displacement per stroke was calculated at 4.8 bar (70 psig) air inlet pressure against a 2 bar (30 psig) head pressure.

**Example:** To pump 189 lpm (50 gpm) against a pressure of 2.1 bar (30 psi) requires 2.8 bar (40 psig) and 62.5 Nm<sup>3</sup>/h (37 scfm) air consumption. (See dot on chart.)

**CAUTION: Do not exceed 8.6 bar (125 psig) air supply pressure.**



Flow rates indicated on chart were determined by pumping water.

For optimum life and performance, pumps should be specified so that daily operation parameters will fall in the center of the pump performance curve.

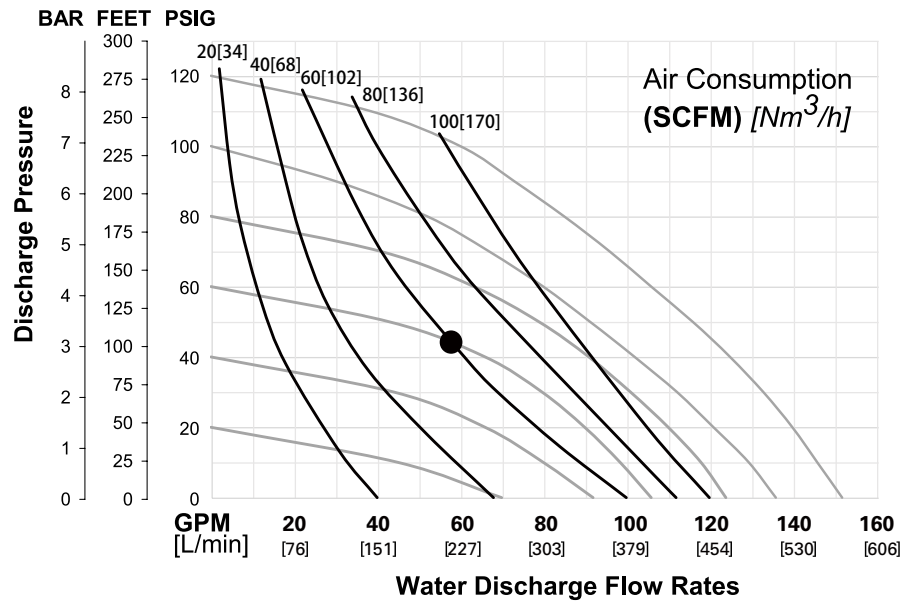
**TZ8 PLASTIC  
FULL STROKE PTFE-FITTED**

Height .....	770 mm (30.3")
Width .....	490 mm (19.3")
Depth .....	333 mm (13.1")
Ship Weight .....	35 kg (77 lbs)
Air Inlet .....	19 mm (3/4")
Inlet .....	51 mm (2")
Outlet .....	51 mm (2")
Suction Lift .....	3.5 m Dry (11.4")
	8.6 m Wet (28.4")
Disp. Per Stroke .....	1.6 l (0.43 gal) <sup>1</sup>
Max. Flow Rate .....	575 lpm (152 gpm)
Max. Size Solids .....	6.4 mm (1/4")

<sup>1</sup>Displacement per stroke was calculated at 4.8 bar (70 psig) air inlet pressure against a 2 bar (30 psig) head pressure.

**Example:** To pump 219 lpm (58 gpm) against a pressure of 3.1 bar (45 psi) requires 4.1 bar (60 psig) and 102 Nm<sup>3</sup>/h (60 scfm) air consumption. (See dot on chart.)

**CAUTION: Do not exceed 8.6 bar (125 psig) air supply pressure.**



Flow rates indicated on chart were determined by pumping water.

For optimum life and performance, pumps should be specified so that daily operation parameters will fall in the center of the pump performance curve.

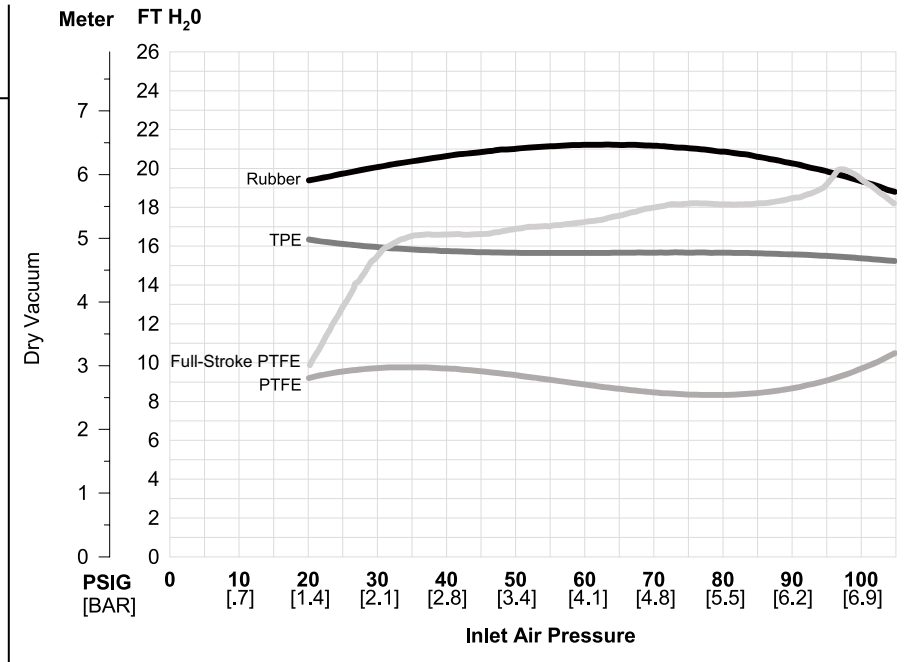




SUCTION LIFT

**TZ8 PLASTIC  
SUCTION LIFT CAPABILITY**

Suction lift curves are calibrated for pumps operating at 305 m (1,000') above sea level. This chart is meant to be a guide only. There are many variables which can affect your pump's operating characteristics. The number of intake and discharge elbows, viscosity of pumping fluid, elevation (atmospheric pressure) and pipe friction loss all affect the amount of suction lift your pump will attain.



**INSTALLATION:** Months of careful planning, study and selection efforts can result in unsatisfactory pump performance if installation details are left to chance.

Premature failure and long-term dissatisfaction can be avoided if reasonable care is exercised throughout the installation process.

**LOCATION:** Noise, safety and other logistical factors usually dictate where equipment should be situated on the production floor. Multiple installations with conflicting requirements can result in congestion of utility areas, leaving few choices for siting additional pumps.

Within the framework of these and other existing conditions, every pump should be located in such a way that the following key factors are balanced against each other to maximum advantage.

**ACCESS:** First of all, the pump's location should be easily accessible. If it's easy to reach the pump, maintenance personnel will have an easier time carrying out routine inspections and adjustments. Should major repairs become necessary, ease of access can play a key role in speeding the repair process and reducing downtime.

**AIR SUPPLY:** Every pump location should have an air line large enough to supply the volume of air that is necessary to achieve the desired pumping rate. For best results, the pumps should use a 5-micron air filter, needle valve and regulator. The use of an air filter before the pump will ensure that the majority of any pipeline contaminants will be eliminated.

**SOLENOID OPERATION:** When pump operation is controlled by a solenoid valve in the air line, three-way valves should be used. This valve allows trapped air between the valve and the pump to bleed off, which improves pump performance. Pumping volume can be determined by counting the number of strokes per minute and then multiplying the figure by the displacement per stroke.

**MUFFLER:** Sound levels are reduced below OSHA specification when using the standard Wilden® muffler element. Other mufflers can be used to further reduce sound levels, but they usually reduce pump performance.

**ELEVATION:** Selecting a site that is well within the pump's dynamic lift capability will ensure that loss-of-prime troubles will be eliminated. In addition, pump efficiency can be adversely affected if proper attention is not given to site location.

**PIPING:** Final determination of the pump site should not be made until the piping concerns regarding each possible location have been evaluated. The impact of current and future installations should be considered ahead of time in order to make sure that inadvertent restrictions are not created for any remaining sites.

The best place possible to locate the pump will be a site featuring the shortest and straightest hook-up of suction and discharge piping. Unnecessary elbows, bends and fittings should be avoided. Pipe sizes should be selected so as to keep friction losses within practical limits. All piping should be supported independently of the pump. In addition, the piping should be aligned so as to avoid placing stresses on the pump fittings.

Flexible hose or expansion joints can be installed to aid in absorbing the force created by the natural reciprocating action of the pump. If the pump is to be bolted down to a solid foundation, a mounting pad that is placed between the pump and the foundation will assist in minimizing pump vibration. If quick-closing valves are installed at any point in the discharge system, or if pulsation within a system becomes a problem, a surge suppressor should be installed to protect the pump, piping and gauges from surges and water hammer.

If the pump is to be used in a self-priming application, be sure that all connections are air-tight and that the suction lift is within the model's operational ability.

**NOTE:** Materials of construction and elastomer materials have an effect on suction-lift parameters.

When pumps are installed in applications involving flooded suction of suction head pressures, a gate valve should be installed in the suction line to permit closing of the line for pump service.

Wilden® TZ-series pumps cannot be used in submersible applications. For submersible applications requiring a single point exhaust, please consider Wilden Pro-Flo X Series pumps.

Pumps in service with a positive suction head are most efficient when inlet pressure is limited to 0.5-0.7 bar (7-10 psig). Premature diaphragm failure may occur if positive suction is 0.7 bar (10 psig) or higher.

**BLOW OUT AIR LINE FOR 10 TO 20 SECONDS BEFORE ATTACHING TO PUMP TO MAKE SURE ALL PIPE LINE DEBRIS IS CLEAR. ALWAYS USE AN IN-LINE AIR FILTER.**

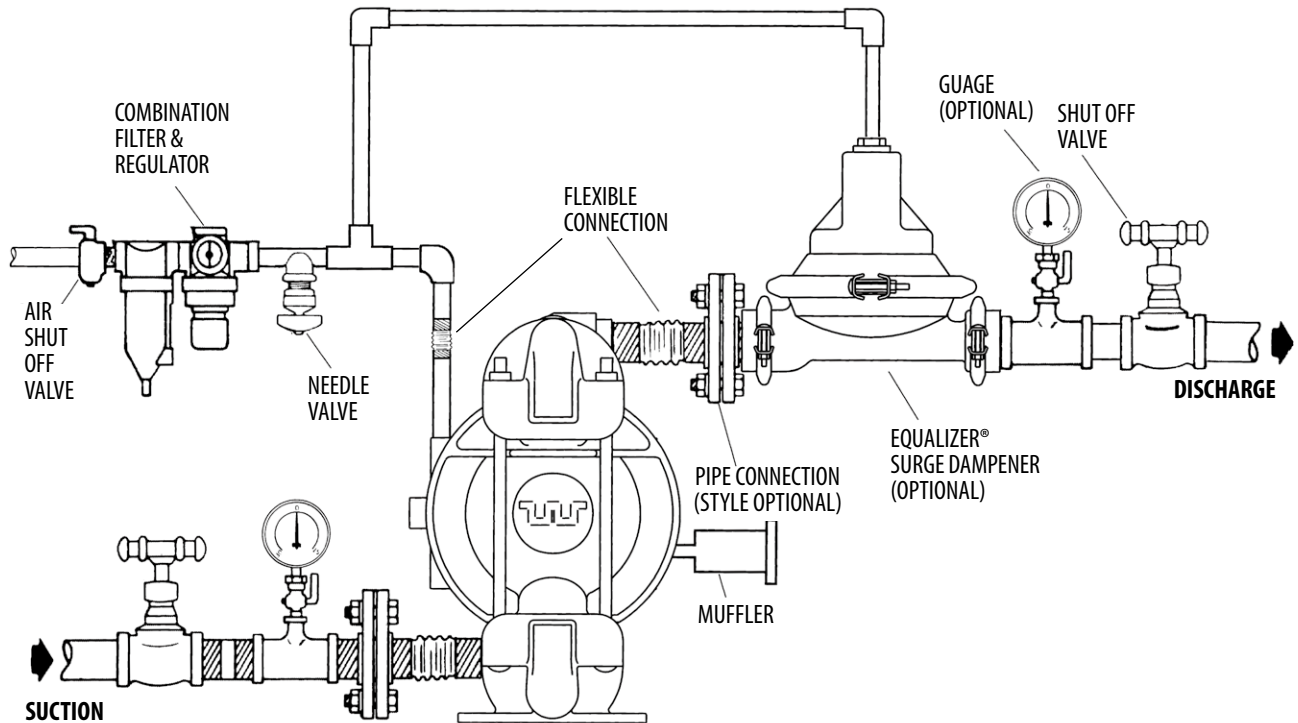
**PUMPS SHOULD BE THOROUGHLY FLUSHED WITH WATER BEFORE INSTALLING INTO PROCESS LINES. FDA AND USDA PUMPS SHOULD BE CLEANED AND/OR SANITIZED BEFORE USE ON EDIBLE PRODUCTS.**

**CAUTION: DO NOT EXCEED 8.6 BAR (125 PSIG) AIR-SUPPLY PRESSURE.**

**AIR-OPERATED PUMPS:** To stop the pump from operating in an emergency situation, simply close the "shut off" valve (user supplied) that is installed in the air-supply line. A properly functioning valve will stop the air supply to the pump, therefore halting output. The shut-off valve should be located far enough away from the pumping equipment so that it can be reached safely in an emergency situation.

**NOTE:** In the event of a power failure, the shut-off valve should be closed if the restarting of the pump is not desired once power is regained.

## SUGGESTED INSTALLATION



*Air Operated Pumps: To stop the pump from operating in an emergency situation, simply close the "shut off" valve (user supplied) installed in the air supply line. A properly functioning valve will stop the air supply to the pump, therefore stopping output. This shut off valve should be located far enough away from the pumping equipment such that it can be reached safely in an emergency situation.*

*Note: In the event of a power failure, the shut off valve should be closed, if the restarting of the pump is not desirable once power is regained.*

## SUGGESTED OPERATION & MAINTENANCE

**OPERATION:** Wilden® TZ-series pumps do not require in-line lubrication. The pump discharge rate can be controlled by limiting the volume and/or pressure of the air supply to the pump (preferred method). An air regulator is used to regulate air pressure. A needle valve is used to regulate volume. The pump discharge rate can also be controlled by throttling the pump discharge by partially closing a valve in the discharge line of the pump. This action increases friction loss, which reduces flow rate. This is useful when the need exists to control the pump from a remote location. When the pump discharge pressure equals or exceeds the air-supply pressure, the pump will stop; no bypass or pressure relief valve is needed and pump damage will not occur. At this point, the pump has reached a "deadhead" condition and can be restarted by reducing the fluid discharge pressure or increasing the air inlet pressure. Wilden® pumps run solely on compressed air and do not generate heat, therefore the temperature of the process fluid will not be affected.

**MAINTENANCE AND INSPECTIONS:** Since each application is unique, maintenance schedules may be different for every pump. Frequency of use, line pressure, viscosity and abrasiveness of the process fluid all affect the parts life of a Wilden® pump. Periodic inspections have been found to offer the best means for preventing unscheduled pump downtime. Personnel familiar with the pump's construction, operation and service should be informed of any abnormalities that are detected during operation.

**RECORDS:** When service is required, a record should be made of all necessary repairs and replacements. Over a period of time, such records can become a valuable tool for predicting and preventing future maintenance problems and unscheduled downtime. In addition, accurate records make it possible to identify pumps that are poorly suited to their applications.

**PUMP WILL NOT RUN OR RUNS SLOWLY.**

1. Check for sticking air valve. If so, wash air valve interior with soap and water.
2. Check for a worn-out air valve. Consult factory for assistance if you suspect an air valve is worn beyond working tolerances and must be replaced.
3. Check center block Glyd™ rings. If worn excessively, they will not seal and air will simply flow through the pump and out of the air exhaust port. Use only Wilden® Glyd™ rings as they are of special construction.
4. Check for rotating piston in air valve. Ensure one air-valve end cap features an anti-rotation pin.

**PUMP RUNS BUT LITTLE OR NO PRODUCT FLOWS.**

1. Check for pump cavitation. Slow pump speed down to match thickness of material being pumped.
2. Check for sticking ball check valves. If material being pumped is not compatible with pump elastomers, swelling may occur. Replace ball check valves and O-rings with the proper elastomers.
3. Check to make sure all suction connections are airtight, especially the clamp band around intake balls.

**PUMP AIR VALVE FREEZES.**

1. Check for excessive moisture in compressed air. If necessary, either install a dryer or hot-air generator for compressed air.

**AIR BUBBLES IN PUMP DISCHARGE.**

1. Check for ruptured diaphragm.
2. Check tightness of clamp bands, especially at intake manifold.

**PRODUCT COMES OUT OF AIR EXHAUST PORT.**

1. Check for ruptured diaphragm.
2. Check for tightness of piston plates to pump shaft.

**PUMP RATTLES.**

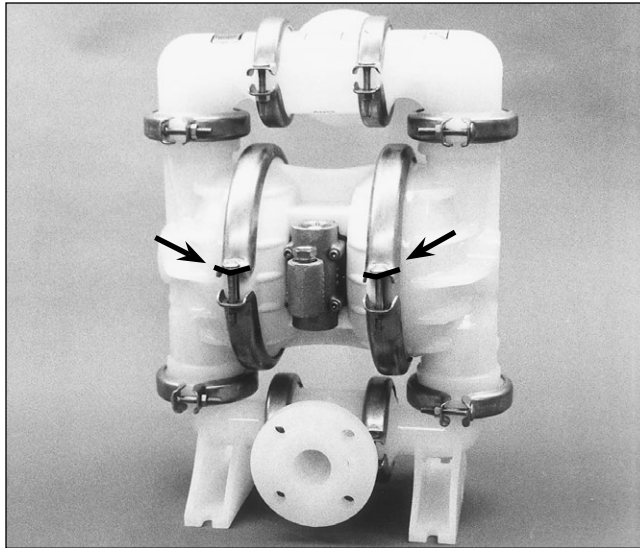
1. Create false discharge head or suction lift.

### DISASSEMBLY INSTRUCTIONS FOR ORIGINAL™ SERIES TURBO-FLO™ Z PLASTIC PUMPS

**CAUTION:** Before any maintenance or repair is attempted, the compressed air line to the pump should be disconnected and all air pressure allowed to bleed from the pump. Disconnect all intake, discharge and air lines. Drain the pump by turning it upside down and allowing any liquid to flow into a suitable container. Be aware of any hazardous effects that may occur upon contact with the process fluid.

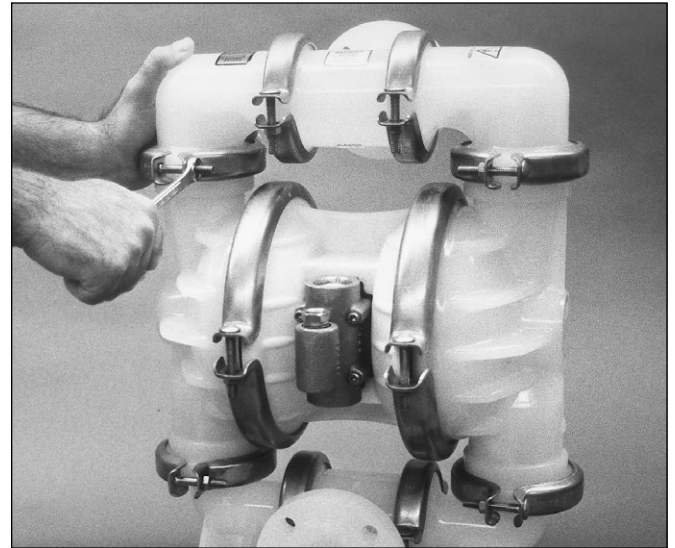
All O-rings used in the pump are made of special material and at any of sign of hardness should be replaced with only factory-supplied parts.

**NOTE:** The model used for these instructions incorporates rubber diaphragms, balls and seats. Instructions for model with PTFE diaphragms, balls and seats are the same except where noted.



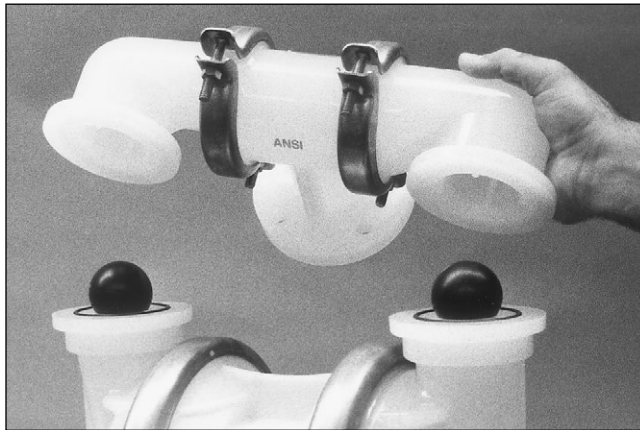
**Step 1.**

Before starting disassembly mark a line from each liquid chamber to its corresponding air chamber. This line will assist in proper realignment during reassembly.



**Step 2.**

Utilizing an appropriate-sized wrench, remove the two (2) clamp bands that fasten the discharge manifold to the liquid chambers. Or depending upon pump model type, use a screwdriver or other long, slim object to loosen the top liquid retainers from the liquid chambers.



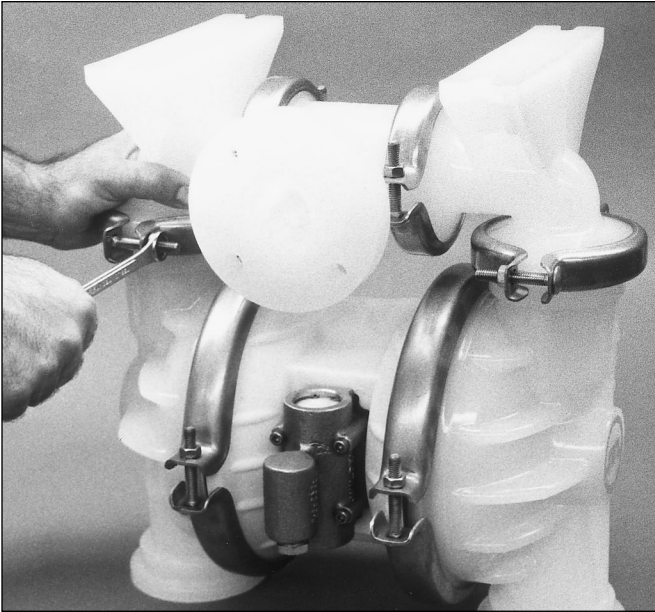
**Step 3.**

Lift away the discharge manifold or top ball retainer to expose the valve balls and seats or ball-guide and seats.



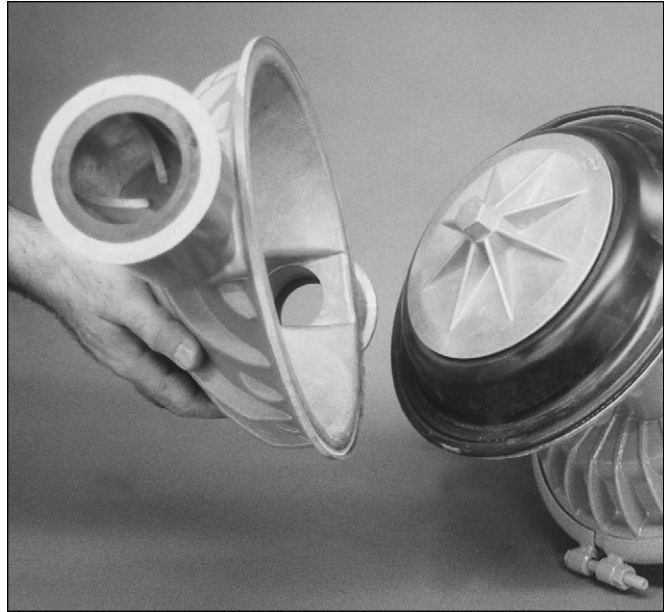
**Step 4.**

Remove the valve balls, seats and O-rings, and ball retainer (if present) from the discharge manifold or liquid chamber, and inspect for nicks, gouges, chemical attack or abrasive wear. Replace worn parts with genuine Wilden® parts for reliable performance. PTFE O-rings should be replaced when reassembled.



**Step 5.**

If applicable, remove the set of clamp bands that fasten the intake manifold to the liquid chambers. Or depending upon pump model type, using the appropriate socket driver, loosen the bottom retainers. Lift the intake manifold away to expose the valve balls and seats. Inspect the intake valve ball cages for excessive wear or damage.

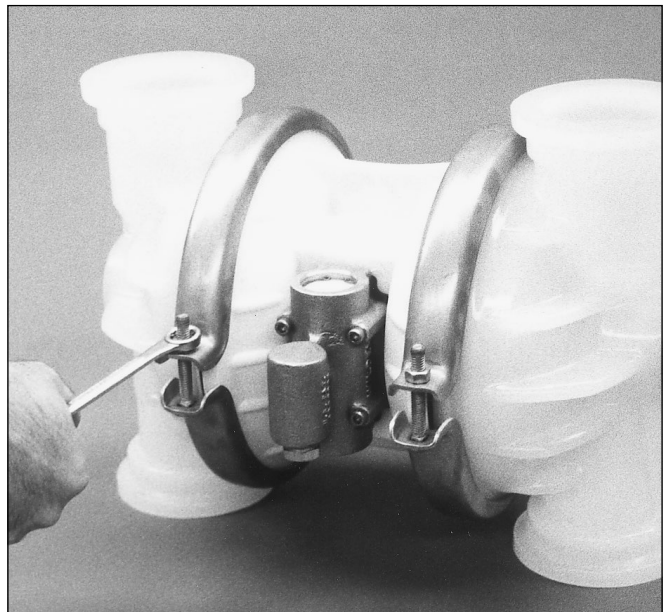


**Step 6.**

Remove the intake valve balls, seats and retainers (if present) from the liquid chamber and inspect for nicks, gouges, chemical attack or abrasive wear. Replace worn parts with genuine Wilden® parts for reliable performance. PTFE O-rings should be replaced when reassembled.



**NOTE:** Normally the inlet and discharge manifold should not be disassembled during regular pump maintenance. Should this be necessary, completely remove and disassemble the manifold clamp bands. Inspect O-rings for wear or damage and replace if necessary.



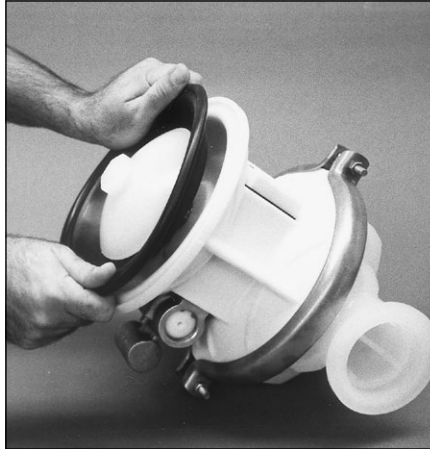
**Step 7.**

Using a socket and box wrench, remove one set of clamp bands that attach the liquid chamber to the center section assembly. Lift liquid chamber away from center section to expose diaphragm and outer piston.



**Step 8.**

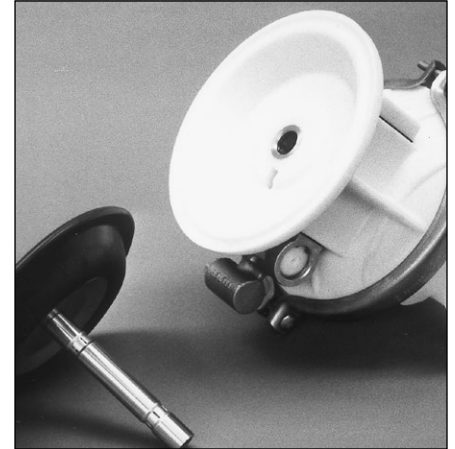
Lift liquid chamber away from center section to expose diaphragm and outer piston.



**Step 9.**

Use a box wrench, adjustable wrench or rotate the diaphragm by hand to remove the diaphragm assembly.

**NOTE:** Due to varying torque values, one of the following two conditions may occur:



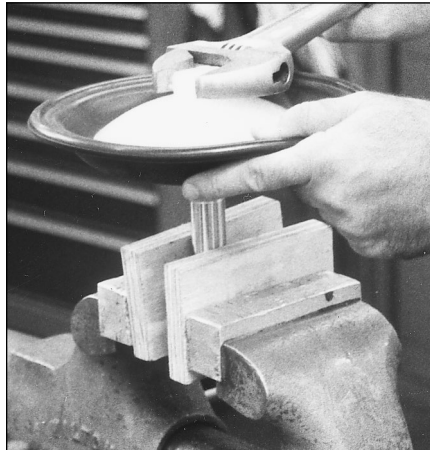
**Step 10A.**

The outer piston, diaphragm and inner piston remain attached to the shaft and the entire assembly can be removed from the center section.



**Step 10B.**

The outer piston, diaphragm and inner piston separate from the shaft, which remains connected to the opposite side of the diaphragm assembly. Repeat disassembly instructions for opposite liquid chamber. Inspect diaphragm assembly and shaft for signs of wear of chemical attack. Replace all worn parts with genuine Wilden® parts for reliable performance.



**Step 11.**

To remove the diaphragm assembly from the shaft, secure the shaft with soft jaws (a vise fitted with plywood or other suitable material) to ensure that the shaft is not nicked, scratched or gouged. Using an adjustable wrench, remove diaphragm assembly from the shaft. Inspect all parts for wear and replace with genuine Wilden® parts, if necessary.

## AIR VALVE / CENTER BLOCK DISASSEMBLY

The center section assembly consists of both the air valve body, piston and the center block. The unique design of the air valve relies only on differential pressure to initiate the diaphragm shift. It is reliable and simple to maintain. The bushing in the center block, along with the diaphragm, shaft, provides the “trigger” to tell the air valve to shift. The following procedure will ensure that the air valve on the Wilden® pump will provide long, trouble-free service.

### AIR VALVE BODY AND PISTON ASSEMBLY AND DISASSEMBLY:

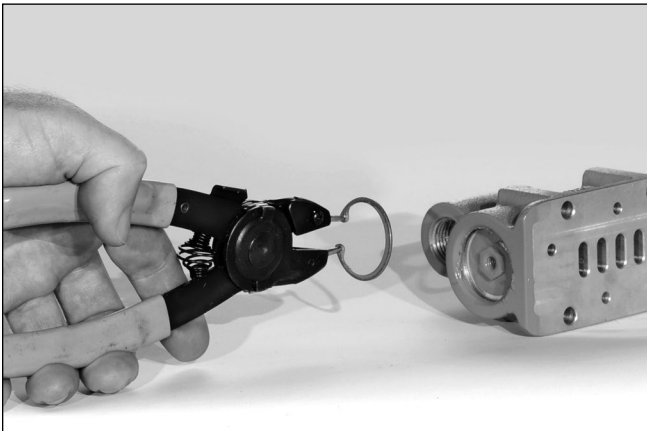
The air valve body and piston can be disconnected from the pump by removing the four (4) socket-head cap screws that

attach it to the center block. The piston should move freely and the ports in the piston should line up with the ports on the face of the air valve body. Inspect the piston for wear, nicks or gouges that could affect pump operation.

If the piston does not move freely in the air valve, the entire air valve should be immersed in a cleaning solution.

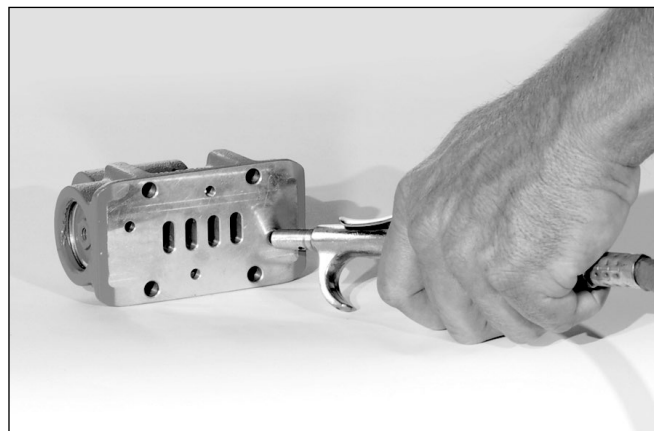
**NOTE:** Do not force the piston to move by inserting a metal object.

Soaking in a cleaning solution of soap and water should remove any accumulation of sludge and grit that is preventing the air valve piston from moving freely. If the air valve piston does not move freely after the cleaning, the air valve should be disassembled as follows:



**Step 1.**

Remove snap-ring from top end of air valve.



**Step 2.**

Apply a blast of air to the opposite end of the air valve piston face.



**Step 3:**

**CAUTION:** The air valve end cap may come out with considerable force. Hand protection such as a padded glove or rag should be used to capture the end cap.

Inspect the piston and cylinder bore for nicks and scoring. Small nicks can usually be dressed out and the piston returned to service. Make sure that the guide pin is straight and smooth

or the piston will not move freely in the cylinder. New O-rings should be installed on the end caps. Lubricate the O-rings and install the end caps, assuring that proper alignment of the piston and cylinder ports is maintained. Reinstall the air valve to the center block of the pump. Tighten per the torque specifications in “Reassembly Hints and Tips”.



# AIR VALVE / CENTER BLOCK DISASSEMBLY

## GLYD™ RING REPLACEMENT:

When the Glyd™ rings become worn they will no longer seal and must be replaced. Consult EOM Section 8 for replacement Glyd™ rings.

See Figure A.

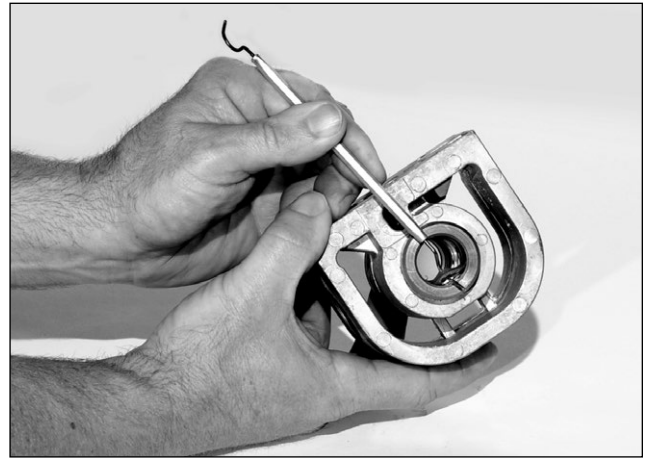


Figure A

## TYPICAL CENTER BLOCK ASSEMBLY:

(For TZ4 & TZ8 Assemblies Only)

The pump's center block features a cast-in bronze bushing. The bushing has 11 grooves cut on the inside diameter. There are seven (7) Glyd™ rings that fit in these grooves. Since these Glyd™ rings form a part of the shifting function of the pump, it is necessary that they be located in the proper grooves. When bushing wear becomes excessive, a new center block must be used.

See Figure B.

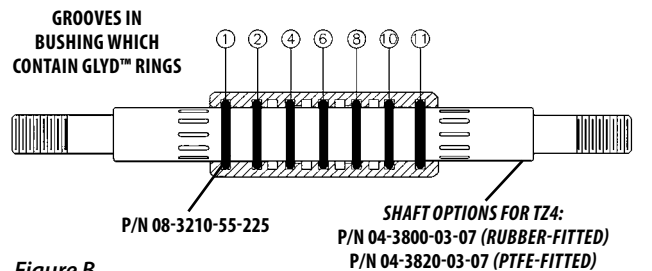


Figure B

SHAFT OPTIONS FOR TZ8:  
P/N 08-3800-09-07 (RUBBER-FITTED)  
P/N 08-3820-03-07 (PTFE/ULTRA-FLEX™-FITTED)

## GLYD™ RING REPLACEMENT/CENTER SECTION

(For TZ1 & TZ2 Assemblies Only)

The pump's center section consists of a molded housing with a bronze bushing. (Bushing is not removable.) This bushing has grooves cut into the inside diameter. Glyd™ rings are installed in these grooves. When the Glyd™ rings become worn or flat, they will no longer seal and must be replaced. This is most easily accomplished by using a tool called an Glyd™ ring pick, available through most industrial supply companies.

An enhanced (01-3800-03-07) shaft should be utilized to maximize performance. The center section Glyd™ rings (01-3220-55) must be installed in the appropriate grooves as shown (1, 3, 6, 8).

See Figure C.

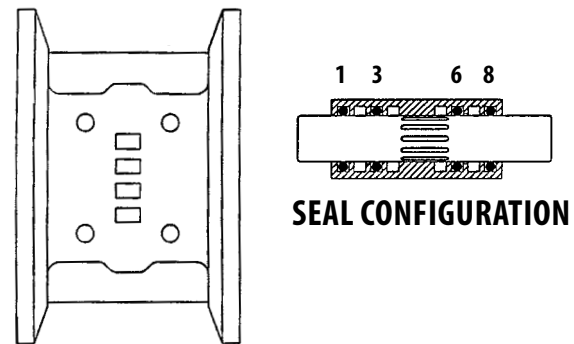


Figure C

## REASSEMBLY HINTS & TIPS

### ASSEMBLY:

Upon performing applicable maintenance to the air distribution system, the pump can be reassembled. Please refer to the disassembly instructions for photos and parts placement. To reassemble the pump, follow the disassembly instructions in reverse order. The air distribution system needs to be assembled first, then the diaphragms and finally the wetted path. Please find the applicable torque specifications on this page. The following tips will assist in the reassembly process:

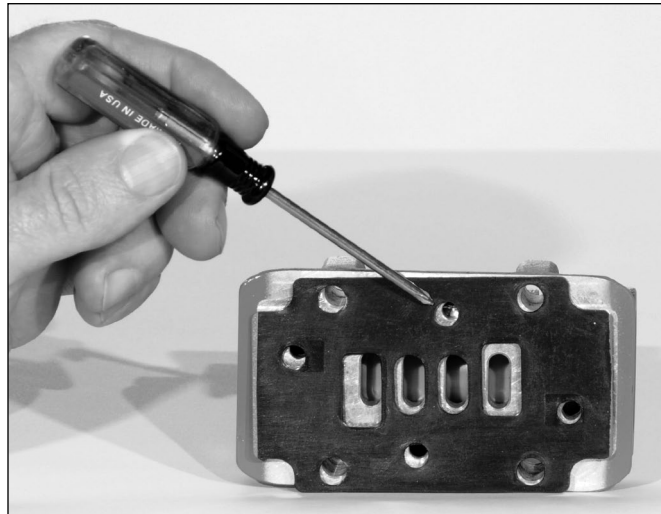
- Clean the inside of the center section shaft bushing to ensure no damage is done to the new seals.
- Stainless-steel bolts should be lubricated to reduce the possibility of seizing during tightening.
- Ensure proper alignment on the sealing surfaces of intake and discharge manifolds.
- Liquid chambers are easier to attach when the diaphragm is inverted. Prior to attaching the second water chamber, push the diaphragm assembly so that it is as close as possible to the center section.

- Level the water chamber side of the intake/discharge manifold to ensure a proper sealing surface. This is most easily accomplished by placing them on a flat surface prior to tightening their clamp bands to the desired torque.
- Be sure to tighten outer pistons simultaneously on PTFE-fitted pumps to ensure proper torque values.
- Ensure proper alignment of mating surfaces between liquid chambers and manifolds before tightening bolts.
- When assembling PTFE-coated hardware, care should be taken to keep the coating intact.
- When installing Glyd™ rings, the use of the Wilden® Ringer Seal tool simplifies seal installation.
- Apply a small amount of Loctite® 242 to the steel bore of the diaphragm assembly fasteners.

**NOTE:** Upon reassembly, ensure the air valve aligns with all ports of the air valve/center block.

### MAXIMUM TORQUE SPECIFICATIONS – TZ8 PLASTIC

Description of Part	Plastic Pumps
Air Valve	6.8 N•m (60 in-lbs)
Outer Piston (PTFE-fitted)	81.3 N•m (58 ft-lbs)
Outer Piston (Rubber-fitted)	81.3 N•m (58 ft-lbs)
Small Clamp Band (All)	6.2 N•m (55 in-lbs)
Medium Clamp Band	10.2 N•m (90 in-lbs)
Large Clamp Band (All)	40.0 N•m (28 ft-lbs)
Center Block Assembly	47.5 N•m (35 ft-lbs)





# EXPLODED VIEW & PARTS LISTING

**TZ8 PLASTIC**
**RUBBER/TPE/PTFE-FITTED**
**PARTS LISTING**

ITEM	DESCRIPTION	QTY.	TZ8/PKAAB/ Rubber/TPE P/N	TZ8/PKAAB/ PTFE P/N
<b>AIR DISTRIBUTION COMPONENTS</b>				
1	Assembly, Brass Air Valve <sup>1</sup>	1	08-2008-07	08-2008-07
2	Block, Center <sup>2</sup>	1	08-3100-01-225	08-3100-01-225
3	Block Gasket, Center	2	08-3520-52	08-3520-52
4	Ring, Center Block Glyd™	7	08-3210-55-225	08-3210-55-225
5	Air Valve Screen	1	08-2500-07	08-2500-07
6	Air Valve Gasket	1	08-2600-52	08-2600-52
7	Screw, SHC, Air Valve (5/16"-18 x 2-1/4")	4	08-6000-03	08-6000-03
8	End Cap w/ Guide	1	08-2300-23	08-2300-23
9	End Cap w/o Guide	1	08-2330-23	08-2330-23
10	O-Ring, Air Valve End Cap (-218), (Ø1.234" x Ø.139")	2	08-2390-52	08-2390-52
11	Retaining Ring	2	08-2650-03	08-2650-03
12	Chamber, Air	2	08-3650-01	08-3650-01
13	Screw, Air Chamber, Flat Head Cap (3/8"-16 x 3-9/16")	3	08-6200-08	08-6200-08
14	Nut, Air Chamber, Cone (3/8"-16)	3	08-6550-08	08-6550-08
15	Muffler (Not Shown)	1	08-3510-99	08-3510-99
<b>WETTED PATH COMPONENTS</b>				
16	Liquid Chamber	2	08-5000-20	08-5000-20
17	Elbow, Discharge	2	08-5330-20	08-5330-20
18	Elbow, Inlet	2	08-5220-20	08-5220-20
19	Manifold, "T" Section	2	08-5160-20	08-5160-20
20	O-Ring, Manifold	4	*	*
21	Band, Clamp Large Assembly <sup>3</sup>	2	08-7300-03-500	08-7300-03-500
22	Band, Clamp Medium Assembly <sup>4</sup>	4	04-7200-03-500	04-7200-03-500
23	Band, Clamp Small Assembly <sup>5</sup>	4	08-7100-03-500	08-7100-03-500
24	Band Bolt, Large Clamp (3/8"-16 x 2-1/2")	4	08-6070-03-500	08-6070-03-500
25	Band Nut, Large Clamp (3/8"-16)	4	08-6450-03	08-6450-03
26	Band Bolt, Medium Clamp (5/16"-18 x 2-1/4")	8	04-6070-03	04-6070-03
27	Band Nut, medium Clamp (5/16"-18)	8	08-6400-03	08-6400-03
28	Band Bolt, Small Clamp (5/16"-18 x 2")	8	08-6050-03-500	08-6050-03-500
29	Band Nut, Small Clamp (5/16"-18)	8	08-6400-03	08-6400-03
<b>VALVE BALLS / VALVE SEATS / VALVE O-RINGS</b>				
30	Ball, Valve	4	*	*
31	Seat, Valve	4	08-1120-20-500	08-1120-20-500
32	O-Ring, Valve Seat (-226), (Ø1.984" x Ø.139")	4	*	*
33	Cage, Ball	4	08-5350-20-500	08-5350-20-500
<b>FULL STROKE RUBBER / TPE COMPONENTS</b>				
34	Shaft	1	08-3800-03-07	N/A
36	Piston, Inner	2	08-3700-01	N/A
38	Diaphragm, Primary	2	*	N/A
39	Piston, Outer	2	08-4550-21-500	N/A
<b>FULL STROKE PTFE COMPONENTS</b>				
34	Shaft, PTFE-Fitted	1	N/A	08-3800-03-07
36	Piston, Inner, PTFE Fitted	2	N/A	84-3700-01
37	Back-up, Diaphragm, PTFE	2	N/A	08-1065-57
38	Diaphragm, Primary, PTFE	2	N/A	08-1040-55
39	Piston, Outer, PTFE-Fitted	2	N/A	08-4550-21-500
<b>REDUCED STROKE PTFE COMPONENTS</b>				
34	Shaft, PTFE-Fitted	1	N/A	08-3820-03-07
36	Piston, Inner, PTFE-Fitted	2	N/A	08-3750-01
37	Back-up, Diaphragm, PTFE	2	N/A	*
38	Diaphragm, Primary, PTFE	2	N/A	08-1010-55
39	Piston, Outer, PTFE-Fitted	2	N/A	08-4600-21-500

\* See elastomer chart.

<sup>1</sup> Air Valve Assembly includes items 5, 8, 9, 10 and 11.

<sup>2</sup> Center Block include item 4.

<sup>3</sup> Large Clamp Band Assembly includes items 24 and 25.

<sup>4</sup> Medium Clamp Band Assembly includes items 26 and 27.

<sup>5</sup> Small Clamp Band Assembly includes items 28 and 29.

All **boldface** items are primary wear parts.



## ELASTOMER OPTIONS

## TZ8 Plastic Pumps

MATERIAL	DIAPHRAGM (2)	BACK-UP DIAPHRAGM (2)	VALVE BALLS (4)	VALVESEATS (4)	VALVE SEAT O-RING (4)	MANIFOLD O-RING (4)
Neoprene	08-1010-51	08-1060-51	08-1080-51	N/A	N/A	N/A
Buna-N	08-1010-52	N/A	08-1080-52	N/A	08-1200-52-500	08-1300-52-500
FKM	08-1010-53	N/A	08-1080-53	N/A	N/A	N/A
EPDM	08-1010-54	08-1060-54	08-1080-54	N/A	N/A	N/A
PTFE	08-1010-55	N/A	08-1080-55	N/A	N/A	N/A
Saniflex™	08-1010-56	08-1060-56	08-1080-56	N/A	N/A	N/A
Wil-Flex™	08-1010-58	N/A	08-1080-58	N/A	08-1200-58-500	08-1300-58-500
Wil-Flex™, EZ-install	08-1022-58	N/A	N/A	N/A	N/A	N/A
PTFE Encapsulated/FKM	N/A	N/A	N/A	N/A	08-1200-60-500	08-1300-60-500
Polypropylene	N/A	N/A	N/A	08-1120-20-500	N/A	N/A



# WARRANTY

# WILDEN

Each and every product manufactured by PSG (Tianjin) Co., Ltd. is built to meet the highest standards of quality. Every pump is functionally tested to insure integrity of operation.

PSG (Tianjin) Co., Ltd. warrants that pumps, accessories and parts manufactured or supplied by it to be free from defects in material and workmanship for a period of five (5) years from date of installation or six (6) years from date of manufacture, whichever comes first. Failure due to normal wear, misapplication, or abuse is, of course, excluded from this warranty.

Since the use of Wilden pumps and parts is beyond our control, we cannot guarantee the suitability of any pump or part for a particular application and PSG (Tianjin) Co., Ltd. shall not be liable for any consequential damage or expense arising from the use or misuse of its products on any application. Responsibility is limited solely to replacement or repair of defective Wilden pumps and parts.

All decisions as to the cause of failure are the sole determination of PSG (Tianjin) Co., Ltd.

Prior approval must be obtained from Wilden for return of any items for warranty consideration and must be accompanied by the appropriate MSDS for the product(s) involved. A Return Goods Tag, obtained from an authorized Wilden distributor, must be included with the items which must be shipped freight prepaid.

The foregoing warranty is exclusive and in lieu of all other warranties expressed or implied (whether written or oral) including all implied warranties of merchantability and fitness for any particular purpose. No distributor or other person is authorized to assume any liability or obligation for PSG (Tianjin) Co., Ltd. other than expressly provided herein.

**PLEASE PRINT OR TYPE AND FAX TO PSG SHANGHAI**

### PUMP INFORMATION

Item # _____	Serial # _____
Company Where Purchased _____	

### YOUR INFORMATION

Company Name _____			
Industry _____			
Name _____		Title _____	
Street Address _____			
City _____	State _____	Postal Code _____	Country _____
Telephone _____	Fax _____	E-mail _____	Web Address _____
Number of pumps in facility? _____		Number of Wilden pumps? _____	
Types of pumps in facility (check all that apply): <input type="checkbox"/> Diaphragm <input type="checkbox"/> Centrifugal <input type="checkbox"/> Gear <input type="checkbox"/> Submersible <input type="checkbox"/> Lobe			
<input type="checkbox"/> Other _____			
Media being pumped? _____			
How did you hear of Wilden Pump? <input type="checkbox"/> Trade Journal <input type="checkbox"/> Trade Show <input type="checkbox"/> Internet/E-mail <input type="checkbox"/> Distributor			
<input type="checkbox"/> Other _____			

**ONCE COMPLETE, FAX TO +86 (22) 2791 1577**

NOTE: WARRANTY VOID IF PAGE IS NOT FAXED TO PSG SHANGHAI



PSG reserves the right to modify the information and illustrations contained in this document without prior notice. This is a non-contractual document. 03-2020

## PSG

No. 2, Hai Tai Hua Ke Er Road Hua Yuan  
Industry Park, Tianjin 300384, PR China

Tel: +86-(0)22-2380 5000

Fax: +86-(0)22-2791 1577

Email: [PSG-China@psgdover.com](mailto:PSG-China@psgdover.com)

[www.wildenpump.com](http://www.wildenpump.com)

Authorized Representative: